

◆ Product Description

MPAM-1x16-017060-50U is a 16-way multi-channel phase & amplitude control system covering 1.7-6GHz. It is composed of a 16-way power divider/combiner and 16 phase & amplitude control channels. The signal is input from a port and output from 16 ports after synchronously independent phase & amplitude adjusting. At any frequency within 1.7-6GHz, the absolute phase and amplitude adjusting accuracy under any amplitude & phase setting combination, is $\pm 2^\circ$ and $\pm 0.2\text{dB}$ maximum from ideal value, control range is $0\sim 360^\circ$ and $0\sim 30/50\text{dB}$, minimum control step is 1° and 0.1dB , the standard size is 3U 19" rack with 110-220V AC-DC converter and fans inside. The control interface is USB and Ethernet option. The software supports the control of single point and scan settings. The system supports reciprocal signal transmission and control.

Main application is accurate wideband signal beamforming system, wideband 5G signal control simulation, wideband Massive MIMO channel simulation system, wideband 5G antenna test system, wideband 5G OTA test system, phase array antenna test and complicated signal environment simulation etc.

Besides 1.7-6GHz system, there are different models can cover 0.5-2GHz, 6~18GHz and 24~40GHz respectively. Number of channels and structure of the system can be customized upon request.

◆ Key Features

Feature	Advantage
Wide Bandwidth	One unit can cover 1.7 to 6GHz wideband application such as all 5G Sub-6 frequency bands, L, S and C bands.
Fine Control Resolution	The system supports 0.1dB and 1° minimum amplitude & phase adjusting step. It will help realize high resolution signal control.
Super High Accuracy	The system can adjust signal amplitude & phase to the range of 0.2dB and 2° maximum from the ideal setting. It can realize the precise signal amplitude & phase control. Higher accuracy is available based on request.
Ultra Low Insertion Loss	Over 1.7 to 6GHz, the insertion loss is from 28 to 30dB Typ. It can offer higher system output power, reduce the cost of amplifier investment.
Higher Channel Isolation	From 1.7 to 6GHz, channel isolation is 38dB minimum at 1.7GHz; Typical isolation is over 46dB up to 6GHz. It reduces the signal interference between channels.
Wide Dynamic Range	The system provides 0 to 30/50dB and 0 to 360° attenuation & phase shift range, which can simulate the various real signal amplitude & phase change. Also as option up to 120dB attenuation is available.
Excellent Stability & Repeatability Performance	Offer the consistent, stable & reliable performance; Reduce the need of calibration & uncertainty of the system performance.
Simple Interface & Software Control	USB interface & GUI is easy for use. DLL files provide easy compatibility with a wide range of software & programming environments.
Small Size	Standard 3U 19" rack is easy for system integration.

◆ Specifications

Electrical Specifications at 23±3°C						
Parameter	Frequency Range	Conditions	Min.	Typ.	Max.	
Number of Channels ¹	1.7-6 GHz			16		
Attenuation Range ²		0.1 dB Step Min.	0	30/50 dB		
Attenuation Step			0.1 dB			
Attenuation Accuracy ³		0-50 dB & 0-360°		±0.1 dB	±0.2 dB	
Phase Shift Range		1° Step Min.	0°		360°	
Phase Shift Step		0-360°	1°			
Phase Accuracy ⁴		0-50 dB & 0-360°		±1°	±2°	
Insertion Loss		0 dB & 0° Set		30 dB	32 dB	
Isolation		0 dB & 0° Set	38 dB	46		
Common / Other RF Port VSWR				1.4:1 / 1.5:1	1.6:1 / 2:1	
Input Power @RF Common Port without Performance Degradation						30 dBm
Maximum Survival Input Power @RF Common Port						40 dBm
Input Power @ Other RF Ports without Performance Degradation						20 dBm
Maximum Survival Input Power @ Other RF Ports					30 dBm	
Supply Voltage			100 VAC		240 VAC	
Control Mode	USB / Ethernet					
RF In / Out Connector	SMA-F					
Size ⁵	19" Rack, 3U					
Operating Temperature	0°C to 50°C					
Storage Temperature	-20°C to 70°C					

Note 1: It can be customized, e.g. 4, 16, 32, 64, 128, or any required number is available.

Note 2: Attenuation range: up to 120dB optional.

Note 3: Higher attenuation accuracy 0.1dB is available based on request.

Note 4: Higher phase accuracy 1° is available based on request.

Note 5: Smaller rack size like 220x290x150mm and customized size is available.

◆ Schematic Diagram

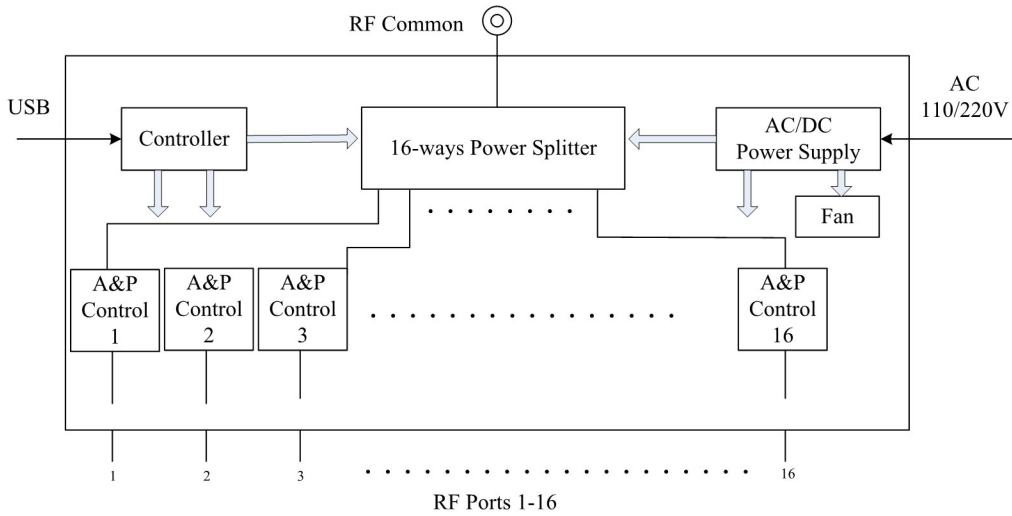

◆ Typical Tested Curve

Phase & Amplitude Control Accuracy

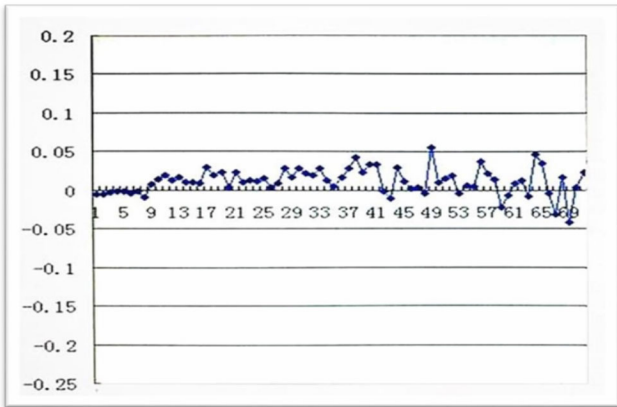

Amplitude accuracy tested data@3.5GHz,
Any combination of phase & attenuation
among 0~50dB & 0~360°

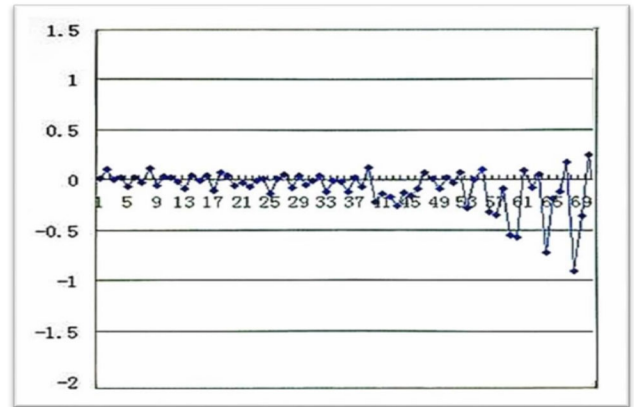

Phase accuracy tested data@3.5GHz,
Any combination of phase & attenuation
among 0~50dB & 0~360°

The X-coordinate shows the number of random sampled points within 0~50 dB & 0-360°

1.7-6GHz Phase Change over Frequency

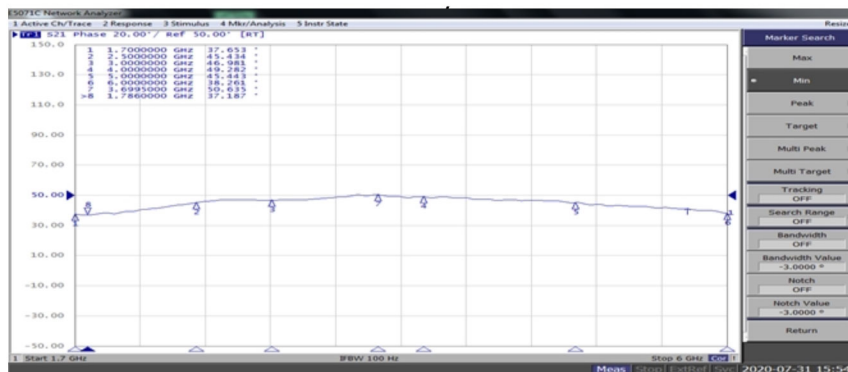

Amplitude & Phase Set: 15dB, 50°

Phase Tested (Max: 50.635° Min: 37.187° Max-Min: 13.448°)

Phase & Amplitude Accuracy VS Temperature

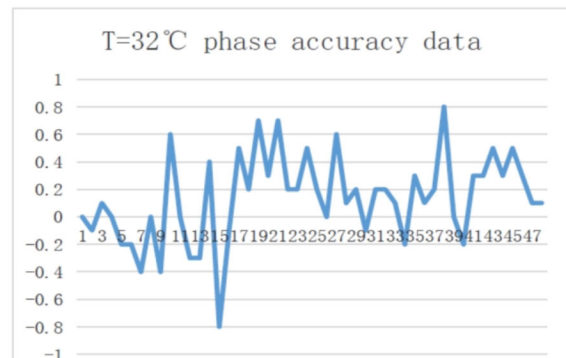
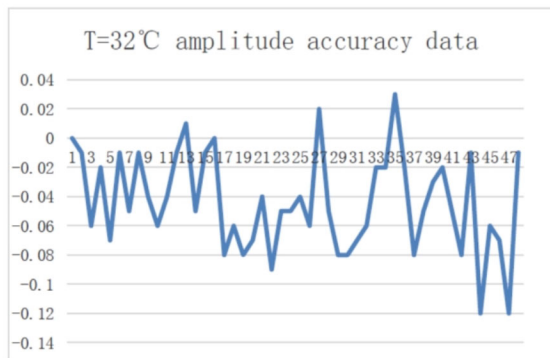
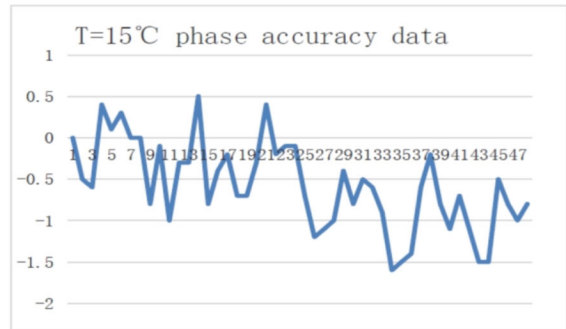
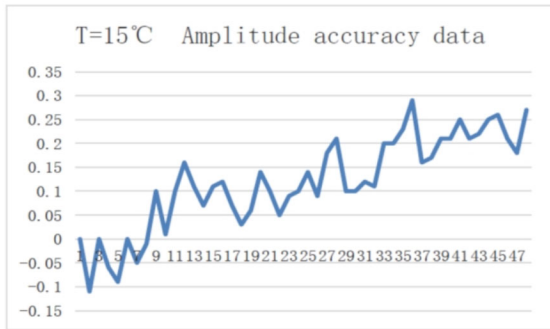

Tested Frequency: 3.5GHz

◆ Example of Application

Wideband 5G Antenna Beamforming Test System & Ideal 5G MIMO Front End Benchmark

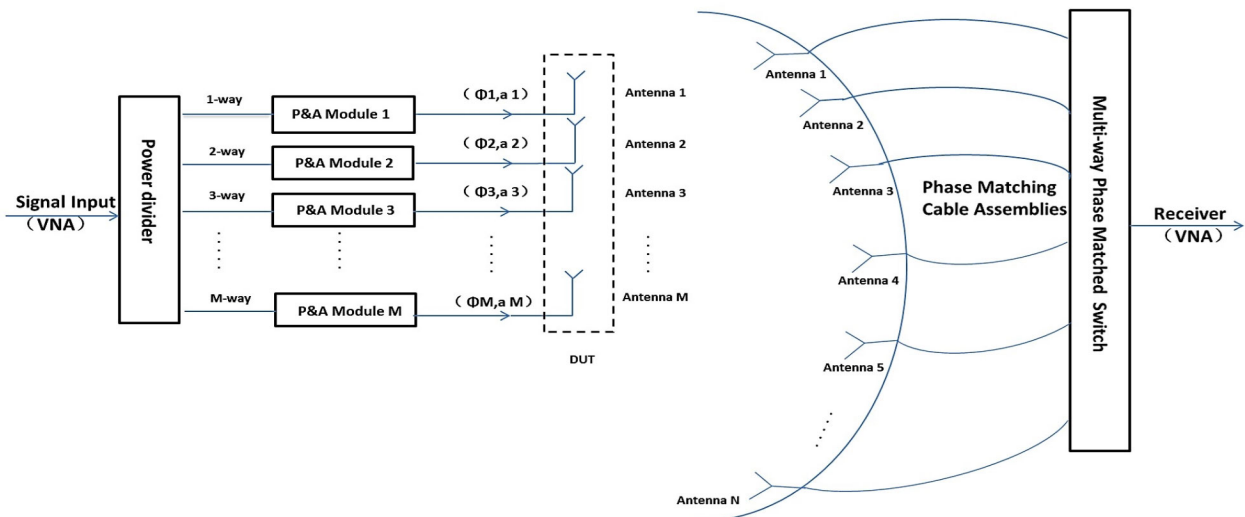

Beamforming Characteristics Test of 5G Antenna

Ideal 5G MIMO Front End Benchmark